

MEGA-RIB

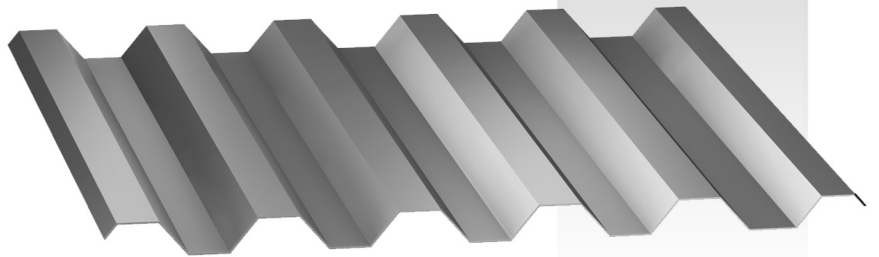

Panel / Trim / Accessories



MEGA-RIB

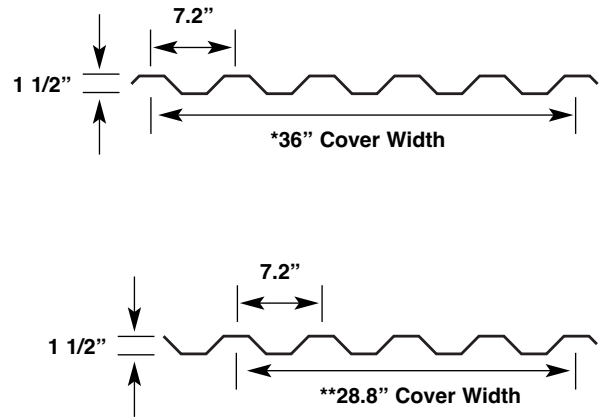
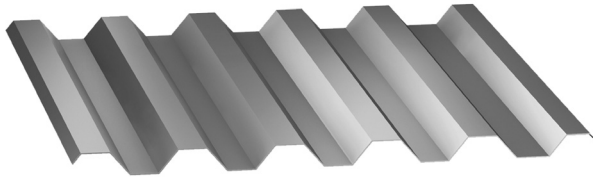

Mega-Rib

Mega-Rib Test Data, Section Properties and Load Tables

For any available Testing Data, Section Properties, or Load Tables, please visit www.mcelroymetal.com. For all other additional information, please contact the **McElroy Engineering Department at 1-800-950-9082**.

Details:

- Minimum slope: 1:12
- Tape sealant required on all slopes
- Adelanto standard coverage for 26 gauge panels : 36"
- All other locations, standard 26 gauge coverage: 28.8"
(specify if 36" coverage is required)
- Can be installed vertically or horizontally

Panel Options:

- Coating:
 - Kynar 500® (PVDF)
- Substrate:
 - Standard 24 GA Galvalume®
 - Optional 22 GA Galvalume
 - Optional 26 GA Galvalume
(Narrow Coverage)
 - Optional 26 GA Galvalume
(Full coverage Adelanto only)
 - Optional 18 and 20 GA Galvalume
(limited availability)

Notes:

- Oil canning is a natural occurrence in metal panels and is not cause for panel rejection.
- Please contact a McElroy representative for specific pricing, lead times, special colors or gauges that may not be on a McElroy Metal color chart.
- Contents in this manual are subject to change without notice. To confirm this book is the most current copy, please visit McElroy's website at www.mcelroymetal.com.

MEGA-RIB

TRIM

26 GA or 24 GA

Simple Base Trim
MGBD

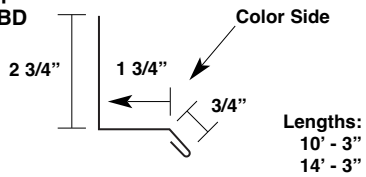

Base Trim
MGBT

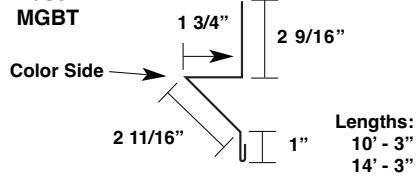

Outside Corner
MGOC

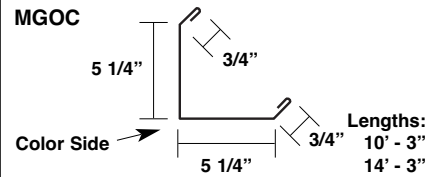

Inside Corner
MGIC

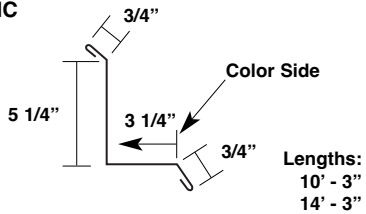

Outside Angle Trim
ITOA

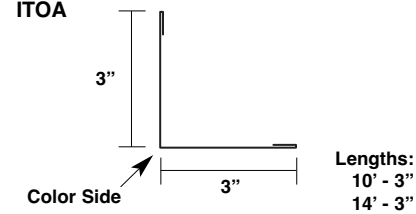

Head and Jamb Trim
MGJT

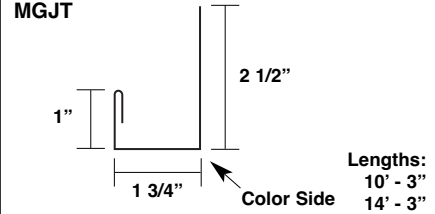

Eave Trim*
MGET

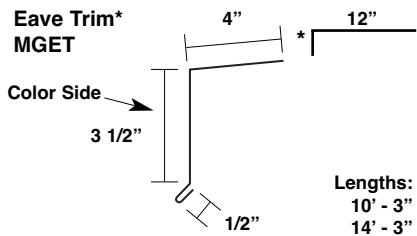

Rake Trim
MGRT

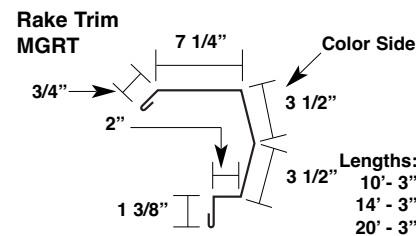

Rake Tie-In Trim
MGEW

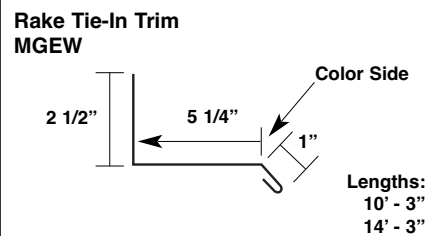

Rake Closure
IT-RTC

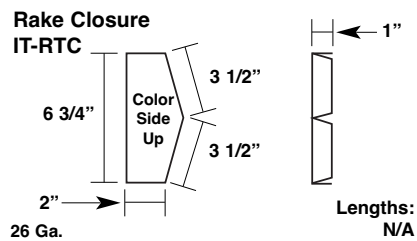

High Side Eave Trim*
ITHS

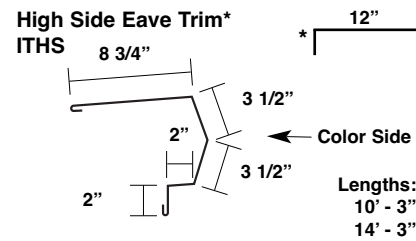

High Side Tie-In Trim*
ITSW

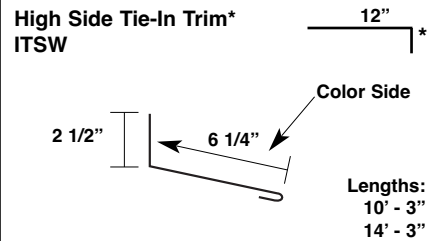

Ridge Cap*
ITRC

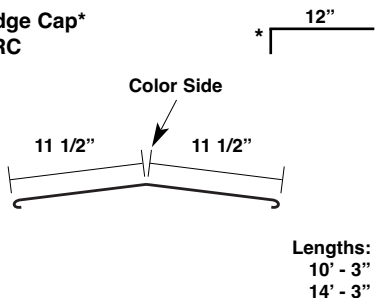

Fixed Peak Box*
(Additional Roof Pitch Available)
IT-PBF

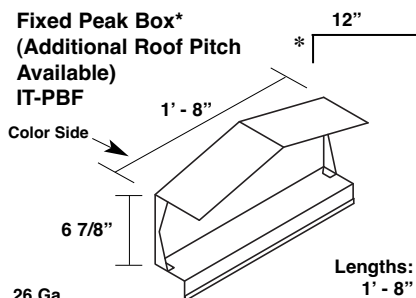

Variable Peak Box
IT-PBV

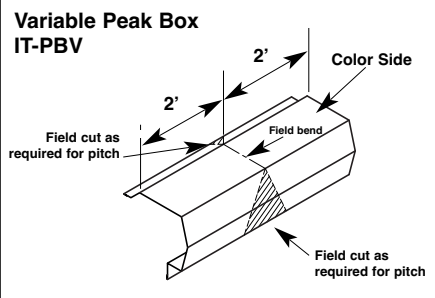

Outside Corner Box for Standard Gutter
(Right Hand Shown Left Hand Opposite)
IT-OCB

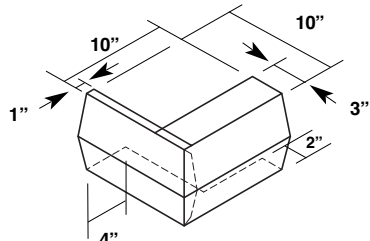

26 Ga.
1/2:12 up to 2:12 roof slopes with standard gutter.

Gutter Corner Box For Standard Gutter
2:12 to 4:12 or with Sculptured Gutter
(Right Hand Shown Left Hand Opposite)
ITGCB

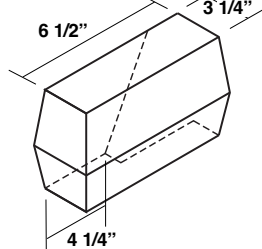

26 Ga.

High Side Corner Box
(Right Hand Shown Left Hand Opposite)
ITHSCB

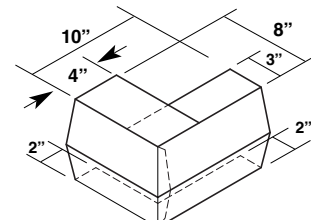

26 Ga.

2 *specify roof pitch * Indicates an open hem - All other hems are closed.

MEGA-RIB

TRIM

26 GA

Gutter
1/2:12 to 2:12
MGG2

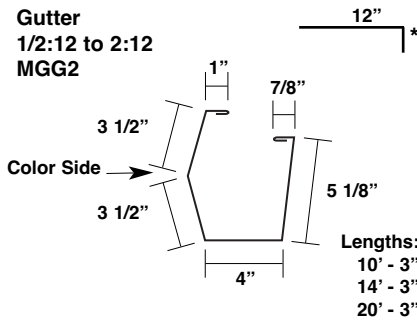

Gutter
2:12 to 4:12
MGG4

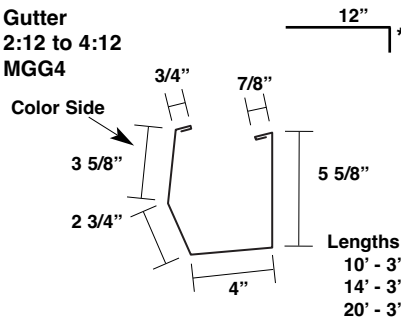

Gutter End Cap
1/2 to 2:12
MGEC2

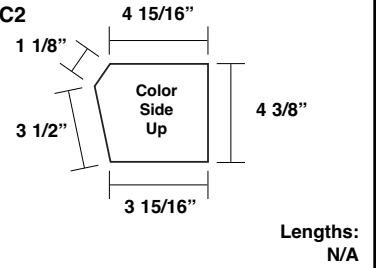

Gutter End Cap
2:12 to 4:12
MGEC4

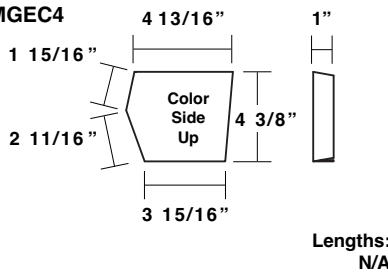

Downspout
BBPPS

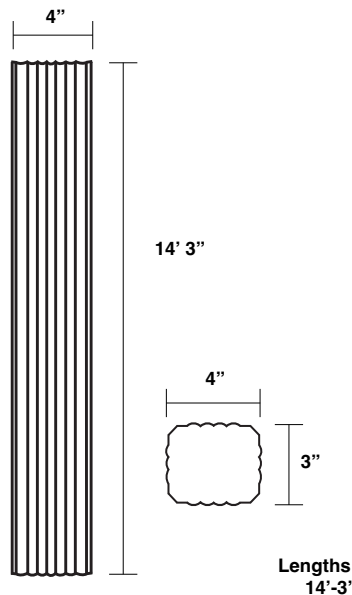

Aluminum Downspout
Outlet Box
BBPOUT

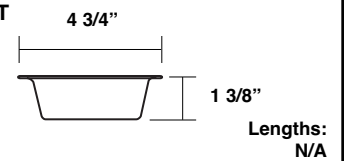

Gutter Strap
MG-GS

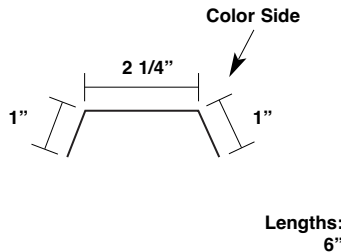

3" x 4"
Downspout Elbow
A-Style
BBPELA

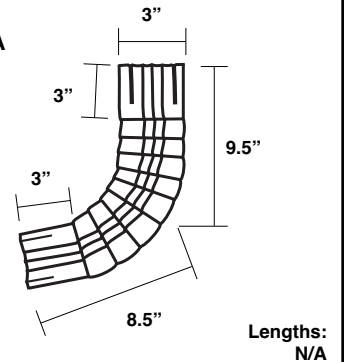

Downspout Strap
BBPDSS

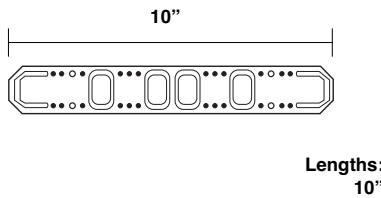

Lock-Seam Downspout - Corner
(Right Hand Corner Shown)

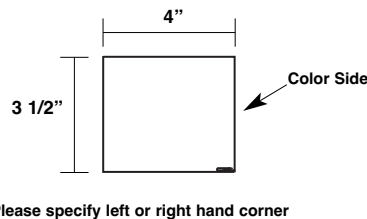

Lock-Seam Downspout - Center

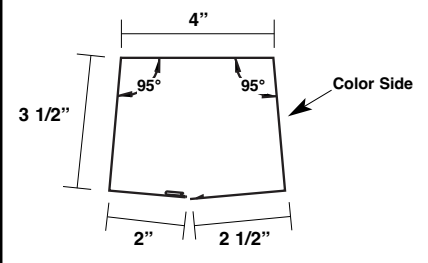

Lock-Seam Downspout Outlet - Standard

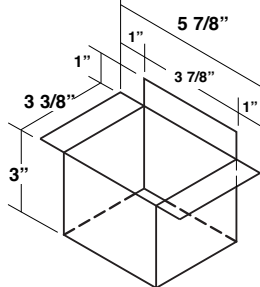

Lock-Seam Downspout Strap

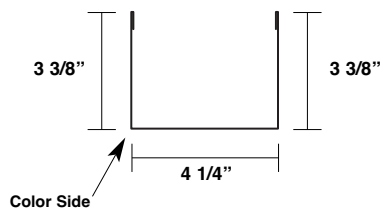

MEGA-RIB

ACCESSORIES

1/4 - 14 x 1 1/4"
TEK2 ZAC
(Part # varies by color)

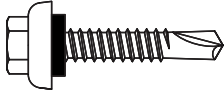

1/4 - 14 x 7/8" LAPTEK ZAC
Self Driller
(Part # varies by color)

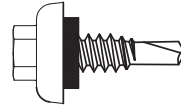

#12 - 14 x 1 1/4" TEK2
HWH W/WASHER
(Part # varies by color)

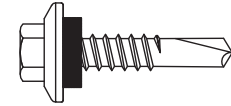

1/4 - 14 x 7/8" LAPTEK
HWH W/WASHER
(Part # varies by color)

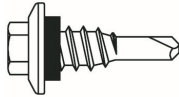

43D PopRivets
(Part # varies by color)

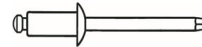

Butyl Tape Sealant 3/32" x 1" x 45'
Item #: 95335

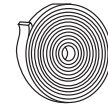

Titebond Caulk Sealant
(Part # varies by color)



Sikalastomer Butyl Tube Sealant
Item #: 95342



Touch-Up Paint Pen
(Part # Varies by Color)



Closure
Item #: 95050



White Fiberglass Panel
Item #: 91145

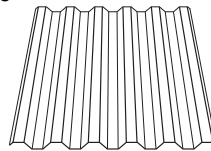

Mitered Mega-Rib Corners for Horizontal Applications

Mega-Rib Outside Corner
(Part # Varies by Color)

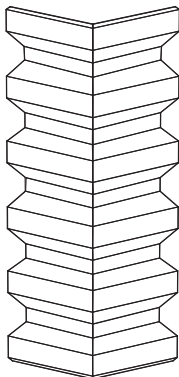

Allow for an extended lead time.
Freight charges will apply.
Please contact a McElroy
Representative for details.

Lengths:
6" x 6"
12" x 12"
18" x 18"
24" x 24"

Mega-Rib Inside Corner
(Part # Varies by Color)

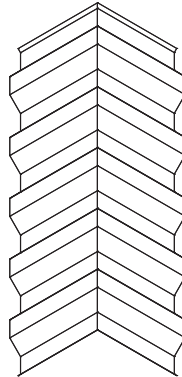

Allow for an extended lead time.
Freight charges will apply.
Please contact a McElroy
Representative for details.

Lengths:
6" x 6"
12" x 12"
18" x 18"
24" x 24"

Notes:

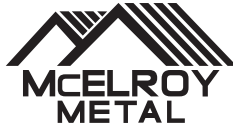

☆ MANUFACTURING LOCATIONS ● SERVICE CENTERS ★ MANUFACTURING AND SERVICE CENTER



CORPORATE OFFICE
1500 HAMILTON RD.
BOSSIER CITY, LA 71111

MANUFACTURING LOCATIONS

- | | | | | |
|--------------|--------------------|------------------|----------------|-------------|
| ADELANTO, CA | ASHBURN, GA | BOSSIER CITY, LA | CLINTON, IL | DIAMOND, MO |
| HOUSTON, TX | LEWISPORT, KY | MARSHALL, MI | MAUSTON, WI | MERKEL, TX |
| | PEACHTREE CITY, GA | SUNNYVALE, TX | WINCHESTER, VA | |

McELROY METAL
SERVICE
C E N T E R

- | | | | |
|--|---|--|--|
| 17031 Koala Road
Adelanto, CA 92301 | 5215 Leo St.
Alexandria, LA 71301 | 1007 Wilso Dr,
Baltimore, MD 21223 | 1500 Hamilton Rd.
Bossier City, LA 71111 |
| 3052 Yadkin Road
Chesapeake, VA 23323 | 9476 Meadowbrook Rd.
Clinton, IL 61727 | 3215 Highway 59
Diamond, MO 64840 | 390 N. Valley Dell Dr.
Fenton, MO 63026 |
| 409 Lovejoy Road
Ft. Walton Beach, FL 32548 | 3014 Lincoln Court
Garland, TX 75041 | 1440 Aldine Bender Road
Houston, TX 77032 | 10504 E. 59th Street
Indianapolis, IN 46236 |
| 9435 US Hwy. 60 W.
Lewisport, KY 42351 | 1020 Veterans Street
Mauston, WI 53948 | 5123 Terminal Dr.
McFarland, WI 53558 | 514 Cave Road
Nashville, TN 37210 |
| 8304 Hwy. 70 E.
North Little Rock, AR 72117 | 613 North Bierdeman Rd.
Pearl, MS 39208 | 8511 Industrial Drive
Pearland, TX 77584 | 2755 Hwy 60
Pendergrass, GA 30567 |
| 7450 Tower Street
Richland Hills, TX 76118 | 8200 Berry Ave. Suite 100
Sacramento, CA 95828 | 1365 Dean Forest Rd.
Savannah, GA 31405 | 7355 Oakley Industrial Blvd.
Union City, GA 30291 |
| | 1144 Silstar Rd.
West Columbia, SC 29170 | 325 McGhee Rd.
Winchester, VA 22603 | |

Website: www.mcelroymetal.com • E-mail: info@mcelroymetal.com